

# 4 Set-up

- 1 Turn key on.
- 2 Verify a solid "N" is on the gear display.

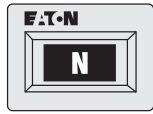

- 3 Start engine.
- 4 Increase engine RPM above 1500. This will unlock the clutch. Failure to do this will set a clutch disengagement code and code and the transmission will not go into gear.

**Note:** Programmable VSS Tamper Resistance options or other artificial engine speed limits which prevent reaching the required 1500 RPM may prevent proper disengagement of the clutch locking device after initial installation. These options may need to be disabled until after the clutch-locking device is disengaged.

**Note:** If ServiceRanger is available, proceed to Step 12.

- 5 Start with the system powered down, the vehicle stationary, and the engine not running.
- 6 Key on and allow the system to completely power up but do not start the engine.
- 7 Select "LOW" mode on the shift controller (UltraShift system will begin to emit an audible tone).
- 8 Select an upshift once (UltraShift gear display will display a "0" with down arrows and discontinue the tone indicating "Special Functions" mode is activated).



- 9 Once in Special Functions mode, select one additional upshift (UltraShift gear display will display a "1" with up arrows indicating UltraShift Touch Point Reset is selected).



- 10 After the "1" is displayed, depress the throttle pedal to the floor and hold for 3-5 seconds (the gear display will change back to a "0" with down arrows indicating the routine has been successfully completed).

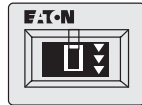

- 11 Key off or select any mode and the UltraShift system returns to normal operation.

- 12 Save clutch data / Recalibrate clutch with Service Ranger

## Gen 3

- Using service ranger, select "Advanced Product Function"
- Select UltraShift transmission model (Gen 3) from menu tree in the upper left.
- Select the VPA/SnapShot Utility and launch the function.
- Read the APF description and select "Next"
- Enter the vehicle info and select "Next."
- Select "VPA" from the dropdown "Data Source" field.
- Enter an output file name and location using Browse Button or use default filename and location shown.

**Note:** If the default filename and location is used, the VPA data file will be saved to the ServiceRangerData folder in the VPA subfolder on the C: drive.

- Select the "start transfer" button to download data from transmission controller and then select "Next."
- The output file can now be viewed, select "Finish"
- Select "Clutch Service Utility" to launch function.
- Read the APF description then select "Next."
- Select the "Clear Clutch Data" button to clear data from transmission controller.
- If successful proceed to next step, if unsuccessful exit function and re-enter. Contact Roadranger Call Center 1-800-826-4357 for help.
- Select the "Calibrate Clutch" button to calibrate new clutch and then Select "Finish" when complete.

# Install an UltraShift™ "DM" Medium Duty Clutch in 4 Steps!

- 1 Measure
- 2 Install Clutch to Flywheel
- 3 Install Transmission
- 4 Set-up



Eaton DM Clutches

Roadranger®

More time on the road

©2011 Eaton Corporation • All rights reserved.  
Printed in USA. CLMT1320 0911 WP

Eaton Corporation • Truck Components Operations  
P.O. Box 4013 • Kalamazoo, MI 49003 USA www.roadranger.com

Reference Material:  
CLMT-1314

## 1 Measure

### Measure Engine Flywheel Housing and Flywheel

Engine flywheel housing and flywheel must meet these specifications or there will be premature clutch wear. Remove old Pilot Bearing. All gauge contact surfaces must be clean and dry. Use a dial indicator and check the following:

#### Flywheel Face Runout

Secure dial indicator base to flywheel housing face. Put gauge finger in contact with flywheel face near the outer edge. Rotate flywheel one revolution. Maximum runout is .008" (.20 mm).

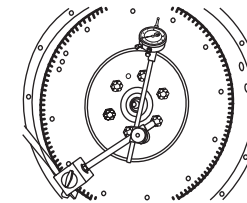

#### Flywheel Housing I.D. Runout

Secure dial indicator base to crankshaft. Put gauge finger against flywheel housing pilot I.D. Rotate flywheel one revolution. Maximum runout is .008" (.20 mm).

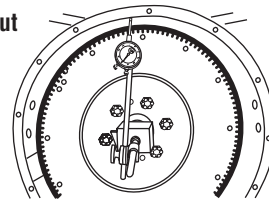

#### Pilot Bearing Bore Runout

Secure dial indicator base to flywheel housing face. Position gauge finger so that it contacts pilot bearing bore. Rotate flywheel one revolution. Maximum runout is .005" (.13 mm).

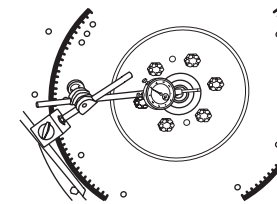

#### Flywheel Housing Face Runout

Secure dial indicator base to flywheel near the outer edge. Put gauge finger in contact with face of flywheel housing. Rotate flywheel one revolution. Maximum runout is .008" (.20 mm).

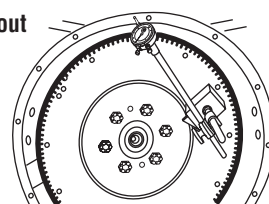

## 2 Install Clutch to Flywheel

- 1 Install two guide studs into two of the clutch mounting holes. It is recommended to use holes at the three o'clock and nine o'clock positions. Be sure to use guide studs to ensure proper alignment of the clutch assembly to the flywheel.
- 2 Use a lifting device to pick up the clutch. Install the alignment shaft through the cover assembly and driven disc. Be sure to properly orient the driven disc. Follow orientation instructions on disc.
- 3 Slide the clutch assembly over the guide studs and start six of the clutch mounting bolts. **Note:** Position the clutch with the balance arrow up as close to vertical as practical. Start at the lower left when tightening the clutch mounting bolts. Remove the guide studs and install the two remaining mounting bolts. Tighten the clutch mounting bolts in a crossing pattern as on any other clutch and torque to 30 - 35 lbs. ft. [41 - 47 N m].

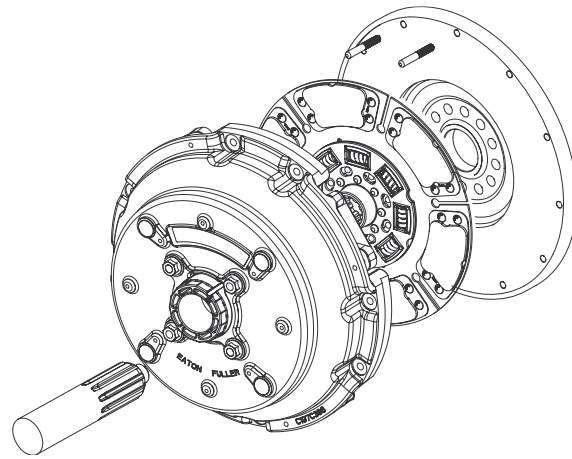

3/8"-16 UNC X 2.25" with lockwashers, minimum grade 5 covered by the Hex Cap Screw specification under ASME B18.2.1 1996. Torque to 30 - 35 lbs. ft. [41 - 47 N m] in a criss cross sequence (See Step 3).

- 4 Remove the alignment shaft.

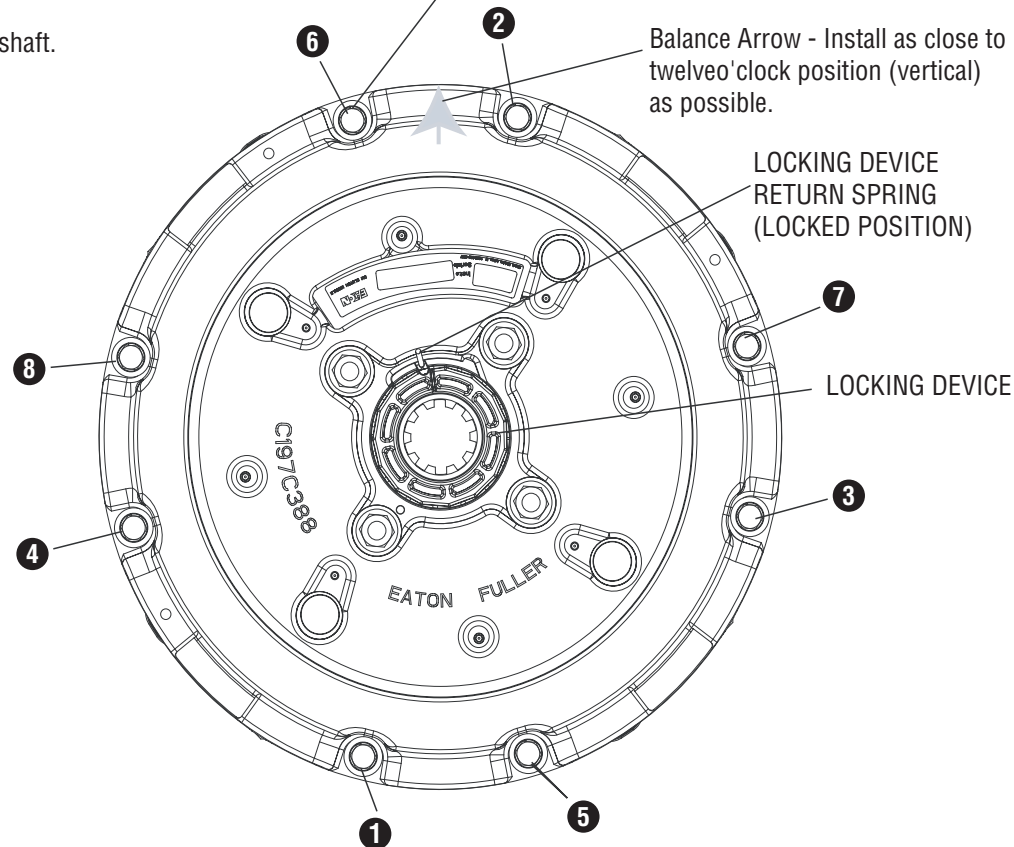

**Note:** The DM clutch is only intended to work with an Eaton UltraShift transmission.

## 3 Install Transmission

**Check Transmission For Wear**  
Replace any worn components.

- 1 **Input Shaft Splines**  
Any wear on the splines will prevent the driven discs from sliding freely causing poor clutch release (clutch drag). Slide discs full length of shaft to check for twisted shaft splines.

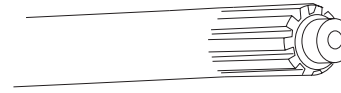

### Fasten Transmission To Flywheel Housing

- 1 Position transmission so it is square to and aligned with engine.
- 2 Mesh splines by moving transmission forward and rotating the input shaft. Do not use excessive force. Do not let the transmission hang unsupported in the disc.
- 3 Install mounting bolts and torque to OEM specs.
- 4 Reconnect UltraShift wiring harness.

